

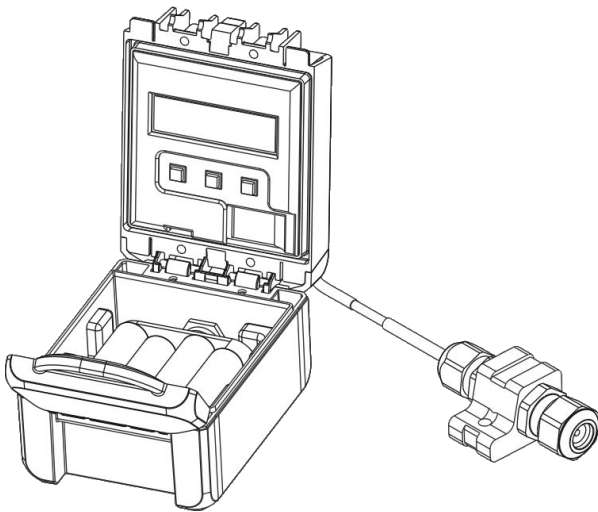

BATLOGGER A/A+

Manual

Firmware version V 2.4



BATLOGGER A

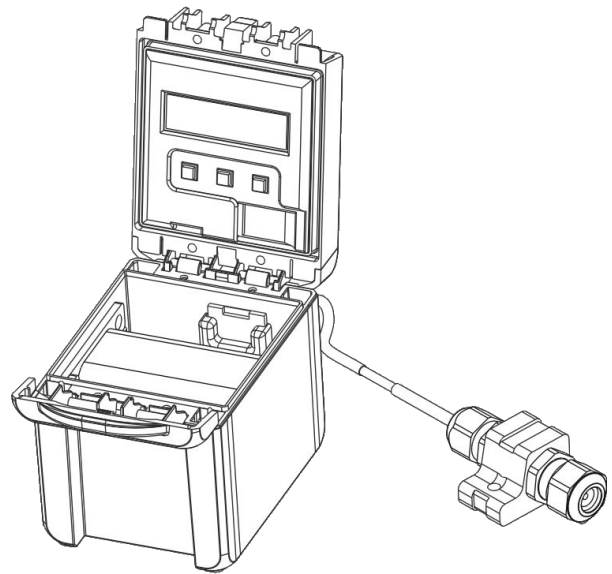

BATLOGGER A+

elekon
●●●

Elekon AG
Cheerstrasse 16
CH-6014 Luzern

www.batlogger.com

Table of contents

1 Safety information and notes.....	4
2 Overview.....	6
2.1 BATLOGGER A.....	6
2.2 BATLOGGER A+.....	7
2.3 General.....	8
2.4 Data storage.....	8
2.5 Accessories.....	9
3 Preparation.....	10
3.1 Inserting/Removing Batteries (BATLOGGER A).....	10
3.2 Inserting/Removing Battery (BATLOGGER A+).....	11
3.2.1 Battery charging.....	11
3.3 Adjusting parameters and settings.....	12
3.4 Connect and install the microphone.....	13
3.5 Close and secure the device.....	14
4 General handling and operation.....	15
4.1 Inserting/Removing SD Card.....	15
4.2 Turn on the device.....	16
4.3 Main menu.....	17
4.4 Device lock (Theft protection).....	18
5 Record bat calls.....	19
5.1 Delayed recording (Recording in time frames).....	19
5.2 Record mode.....	21
5.3 Trigger modes.....	22
5.3.1 CrestAdvanced trigger.....	22
5.3.2 Crest trigger.....	22
5.3.3 Period trigger.....	22
5.4 Interval recording (Record in time intervals).....	22
6 Process recordings.....	23
6.1 Select folder.....	23
6.1.1 Delete folder.....	23
6.2 Select recording file.....	24
6.2.1 Analyse recording.....	24
6.2.2 Delete recording.....	24
7 Recording location.....	25
8 Setup (Settings).....	26
8.1 Operation.....	26
8.2 Setup-Menu.....	27
8.2.1 Setup 1/7: Delay Record.....	27
8.2.2 Setup 2/7: Trigger.....	29
8.2.3 Setup 3/7: Audio.....	31
8.2.4 Setup 4/7: Location.....	31
8.2.5 Setup 5/7: SD card.....	32
8.2.6 Setup 6/7: Miscellaneous.....	33
8.2.7 Setup 7/7: Exit setup.....	34
9 Recordings and Files.....	35
9.1 The audio data file "xxxxxxx.wav".....	35
9.2 Meta data file "xxxxxxx.xml".....	36
9.3 Log file "BATREC.log".....	37
9.4 Parameter file "BATAPARS.xml".....	37
9.5 Google-Earth file "route.kml".....	37

10 Troubleshooting.....	38
10.1 Checklist.....	38
10.2 Replace microphone.....	39
10.3 Test microphone.....	39
10.3.1 Record silent spectrum.....	39
10.3.2 Record a test tone.....	39
10.4 Update device firmware.....	40
11 Technical specifications.....	41
12 Exclusion of Warranty.....	42
13 Service and Support.....	42

1 Safety information and notes

Before operating the device, please read this manual thoroughly and retain it for reference.



General safety information:

- Ignoring the associated information given under this symbol may result in serious injury or even death.
- Use the device only in its intended manner. Any other uses may lead to damage to the device or in the vicinity of the device.
- Do not place the device on or near a heat source (heating, fire, etc.). Protect it against high temperatures and temperature fluctuations
- Place the device so that it can not become a danger due to dropping, falling etc.
- The device must be kept out of reach of children.
- Make sure no foreign objects (coins, pins etc.) or liquids can enter the unit.
- Only use the specified supply voltage for the device.
- When installing the device and the microphone cable it must be ensured that it can not come into contact with other live objects. Also, make sure that no electric shock caused by lightning, high-voltage power lines etc. can occur. Faulty connections and damaged cables can cause electric shock or fire.
- Be sure the use of this device is allowed in the country and in the environment required. The use of this device may be dangerous and has to be avoided in the following areas:
- Where it can interfere with other electronic devices in environments such as hospitals, airports, aircrafts, etc.
- Where there is risk of explosion such as gasoline stations, oil refineries, etc.
- It is responsibility of the user to enforce the country regulation and the specific environment regulation.
- Do not use the unit while operating a vehicle (such as a bicycle, motorcycle or car).
- An alteration or modification of the device affects the product safety. Caution: Risk of injury!
- Do not perform any repairs.
- Handle the device with care. It can be damaged through impact, hits or dropping even from low height.
- Avoid operation in close proximity of strong magnetic or electromagnetic fields transmitting antennas, RF generators or near electronic devices such as mobile phones. This may affect proper operation.
- By handling error, unit malfunction, or during repair work the stored data may be destroyed or erased. It is therefore advisable to make a backup copy of important data, on the PC hard drive.



Batteries (BATLOGGER A): This device requires 8 standard AA batteries (1.2V – 1.5V). The use of rechargeable batteries is strongly recommended. Use only batteries of the same or equivalent type. Insert the batteries in the removable battery holder as indicated and insert it inside the device (see figure below). Battery polarity must be followed. Keep batteries away from children. Dispose of exhausted batteries according to local legal requirements. Do not dispose them by throwing away with normal household rubbish. Remove batteries from the unit if it will be not used for long period of time. Exhausted batteries should be removed from the battery compartment to prevent over-discharge, which can cause leakage and may cause damage to the device. Avoid short circuiting the contacts in the battery compartment and battery terminals. Do not attempt to open or repair the batteries. Do not expose the batteries to high temperatures or allow moisture or humidity of any kind to come into contact with it. When transporting and storing several BATLOGGER A together, the corresponding regulations have to be followed.



Li-Ion battery (BATLOGGER A+): Do not attempt to open or repair the battery. Do not short circuit the battery. Do not expose the battery to high temperatures or allow moisture or humidity of any kind to come into contact with it. Only use original spare parts. When transporting and storing several BATLOGGER A+ together, the corresponding regulations have to be followed. The battery should be charged at temperatures between 0°C and 40°C and discharged at a temperature between -10°C and +50°C. Using the battery at temperatures outside of this ranges may cause the battery to become hot or to break and may also harm the performance of the battery or reduce the battery's expectancy.



Environmental conditions: The BATLOGGER A is housed in a robust, weatherproof case. The case must be properly closed and secured to maintain weatherproofness. All external connectors are protected against moisture and rain only if the corresponding cable is properly connected.



Microphone / Ultrasonic sensor: An active electret microphone is used as ultrasound sensor. Attention has to be paid to a proper fitting of the microphone in its plug. The microphone itself can be damaged by water. It must be protected from dirt, rain and extreme humidity, and it requires corresponding positioning. A defective microphone can lead to unusable or incorrect data.



Measurement device: The BATLOGGER A is a very sensitive measurement device and must be treated as such. To achieve useful and reproducible results you should consider some preparation measures and familiarize yourself with the device. Some basic knowledge about bats and ultrasound is required.



Maintenance and care: Only clean this device with a slightly damp, lint-free cloth and do not use aggressive cleaning agents. Ensure that no water intrudes the device.



Note on environmental protection: Electric and electronic devices as well as batteries must not be disposed of with household waste. Consumers are obliged by law to return electrical and electronic devices as well as batteries at the end of their service lives to the public collection points set up for this purpose or point of sale. Details to this are defined by national law of the respective country. This symbol on the product, the instruction manual or the package indicates that a product is subject to these regulations. By recycling, reusing the materials or other forms of utilising old devices/batteries, you are making an important contribution to protecting our environment.

2 Overview

2.1 BATLOGGER A

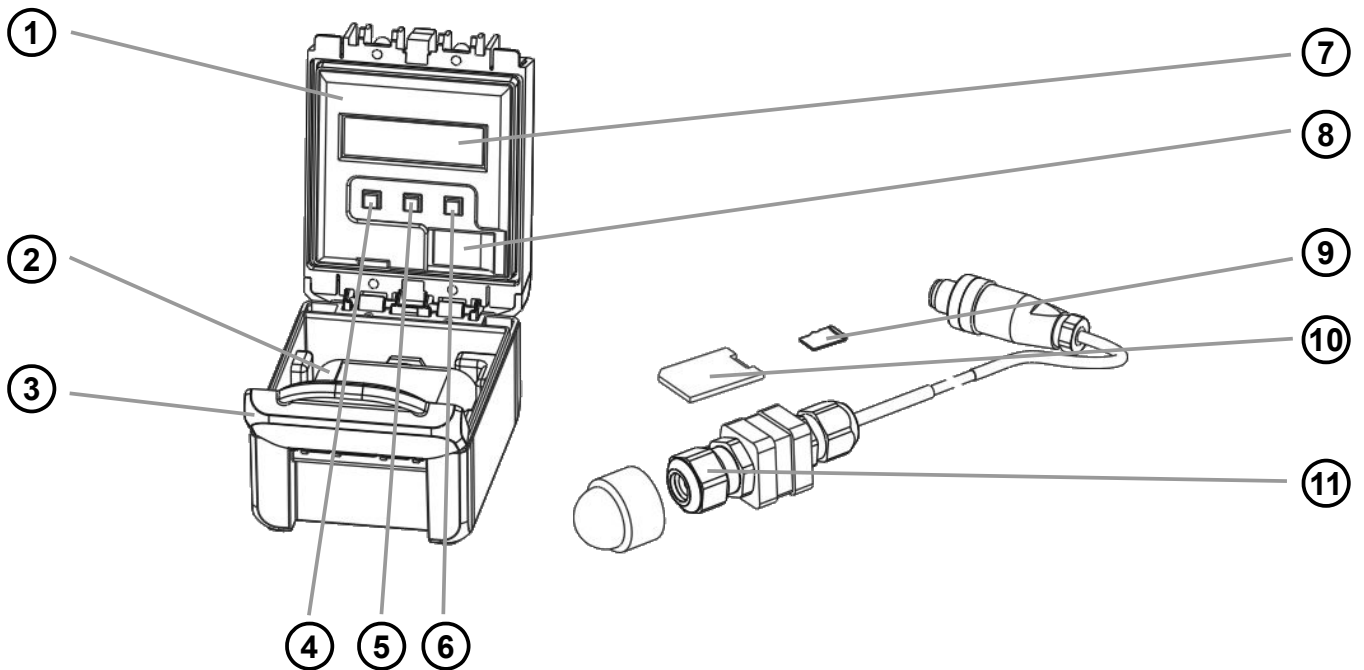

- ① Case with cover
- ② Battery holder
- ③ Closing latch
- ④ Left Key (<<)
- ⑤ Menu Key (MENU)
- ⑥ Right Key (>>)

- ⑦ LC-Display
- ⑧ Micro SD card slot
- ⑨ Micro SD card
- ⑩ SD card adapter
- ⑪ Microphone with cable 2m and cover
- ⑫ Microphone connector

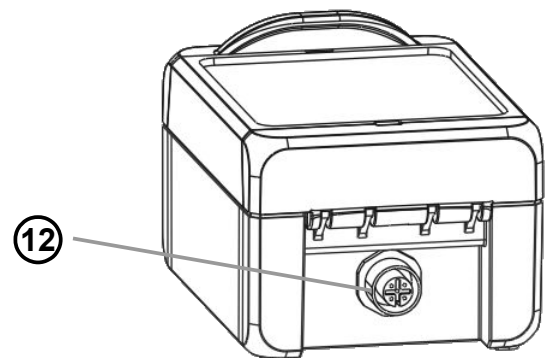

2.2 BATLOGGER A+

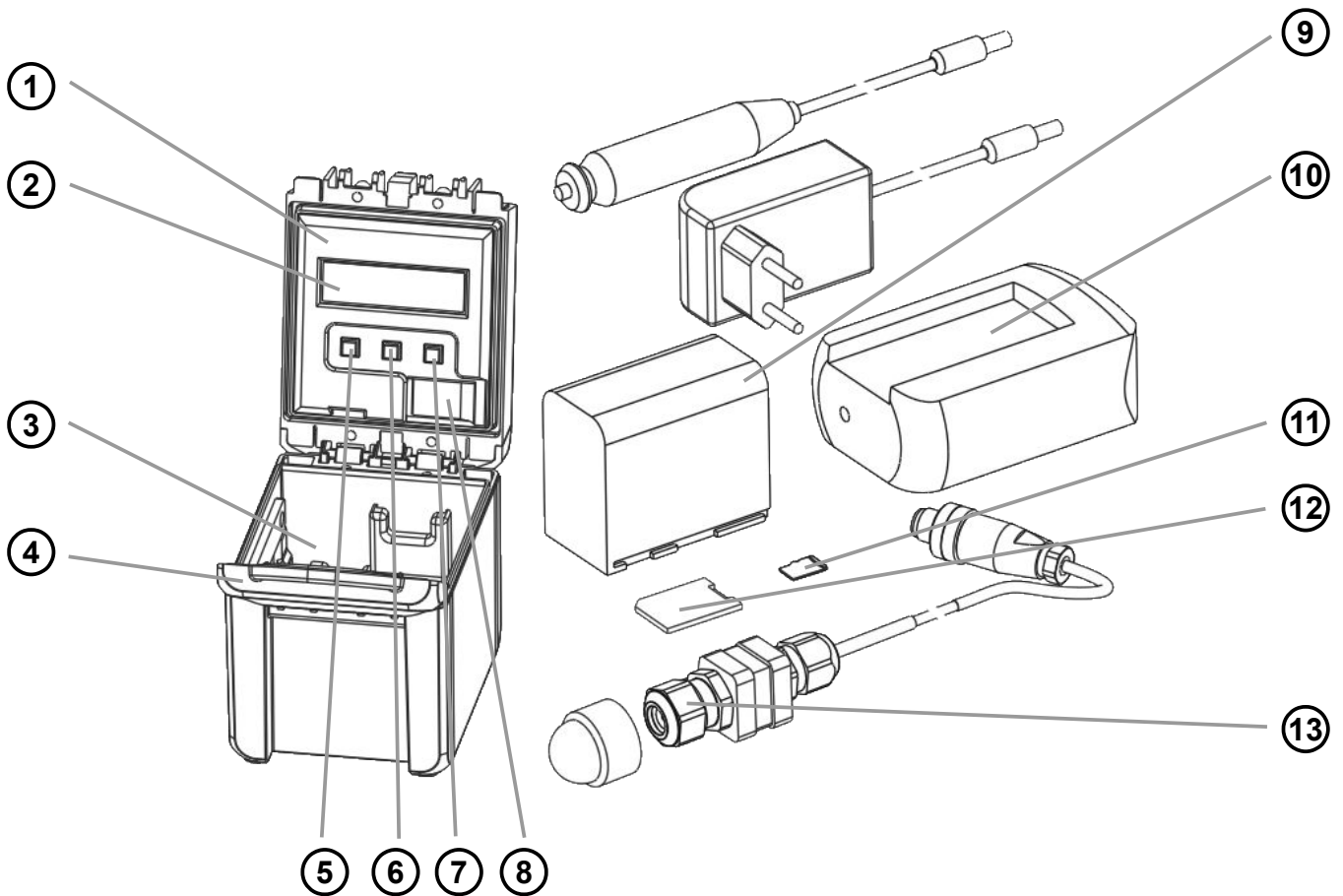

- | | |
|-------------------|--------------------------------------|
| ① Case with cover | ⑧ Micro SD card slot |
| ② LC-Display | ⑨ Battery |
| ③ Battery slot | ⑩ Charger with power adapters |
| ④ Closing latch | ⑪ Micro SD card |
| ⑤ Left Key (<<) | ⑫ SD card adapter |
| ⑥ Menu Key (MENU) | ⑬ Microphone with cable 2m and cover |
| ⑦ Right Key (>>) | ⑭ Microphone connector |

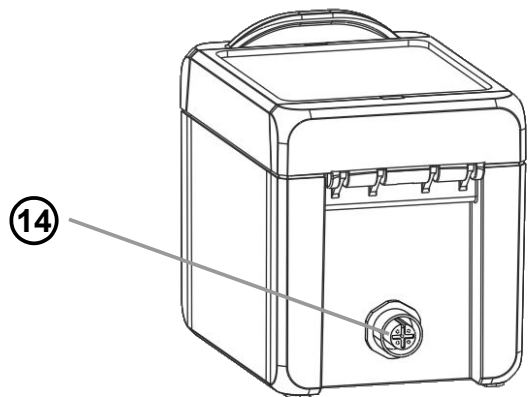

2.3 General

The BATLOGGER A/A+ is a data logger, which records ultrasound vocalisations of bats in real-time, and stores them for later processing on a micro SD / SDHC memory card (real-time recording system).

In a real-time recording system, the ultrasonic signal is digitized directly without change and with high sampling rate. Hereby the BATLOGGER A/A+ continuously analyses the signal and only stores it to the SD card when bat activity is detected. The signal is recorded to internal RAM and subsequently, if certain criteria is fulfilled, stored as recording files (sequences of echolocation calls) onto SD card.

Apart from the bat calls, which are stored as standard audio WAVE files, additional information is written in text format into a “.xml” file, which stores all the settings of the BATLOGGER A/A+ at the time of recording, including time, date and location of the recording, and the current temperature.

To allow a later overview over all deployments of the device, its operating state is being written to a “LOG” file on the SD card.

The BATLOGGER A/A+ is thus especially suitable for autonomous operation and unattended monitoring. The BATLOGGER A/A+ is primarily used stationary, which is often referred to as passive monitoring.

The only difference between BATLOGGER A and BATLOGGER A+ is the battery type (size) and the corresponding operation time.

2.4 Data storage

The audio files are stored on the micro SD memory card as #****.wav files (where # = 4 digit serial number of the device), with consecutive numbering (****). For every #****.wav file, a #****.xml file is stored, which contains all parameter settings, date, time, geographic position and temperature at the time of recording of the corresponding WAVE file. Ultrasound data of the microphone are first written to the internal Random Access Memory (RAM) of the device. After termination of a single recording sequences (Recording...), the data is stored automatically from RAM to the SD card (Saving... #****.wav). During this storage time (duration depends on file size and card type), the device is blocked.



SD card: The device uses micro SD / SDHC /SDXC cards with FAT32 file system as storage media. When the term “SD card” is used, always a micro SD / SDHC / SDXC card is meant. Test have shown, that cards of different vendors may vary in writing and erasing speed. We refrain from giving recommendations for specific products or vendors, as offered sizes and technologies change constantly, which may also influence card performance. SD cards may have a write protect switch that prevents writing to the cards when the switch is on LOCK. Please make sure to disable the write protect switch of the SD card before using it.



SDXC cards: SD cards larger than 32 GB (SDXC cards) may be formatted with exFAT upon delivery and must be formatted by with FAT32 before use. To do this insert the SD card into the SD card slot and turn on the device. You will be asked whether the card should be formatted. Press to format and confirm with . CAUTION: All data on the SD card will be deleted.



SD card content: A recent version of BATPARS Editor software (Windows and Mac) is stored on the included SD card. The executable file is in directory Software/BATPARS and can be started from there directly. Installation is not required.

A recent version of BatExplorer PC software is stored on the included SD card. It must be installed on the computer before first use. It can be found in the directory Software/BatExplorer.

2.5 Accessories

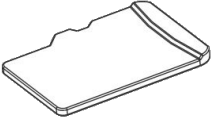
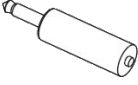
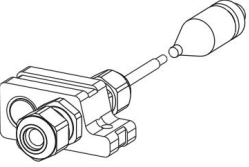
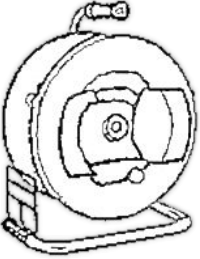
Part	Description	Part#
<p>Micro SD card</p> 	<p>Micro SD / SDHC / SDXC cards up to 128 GB card size can be used (32 MB to 128 GB tested). The card must be formatted as FAT32. (1x micro SD card, 16GB included)</p>	
<p>Ultrasonic microphone FG black</p> 	<p>Ultrasonic microphone FG black or FG green can be used. To replace the microphone, see chapter 10.2. (1x FG black included)</p>	212.233
<p>MC32, Microphone cable with Tester</p> 	<p>Waterproof microphone cable 2m with integrated test signal generator. Compatible with microphones FG black and FG green. (optional)</p>	212.028
<p>Microphone extension kit 100m green</p> 	<p>Extend the operating freedom with the 100 meter extension cable and the FG green microphone. Place the microphone on top of a measurement mast or tree while having the device accessible on the floor. (optional)</p>	212.031

3 Preparation

3.1 Inserting/Removing Batteries (BATLOGGER A)

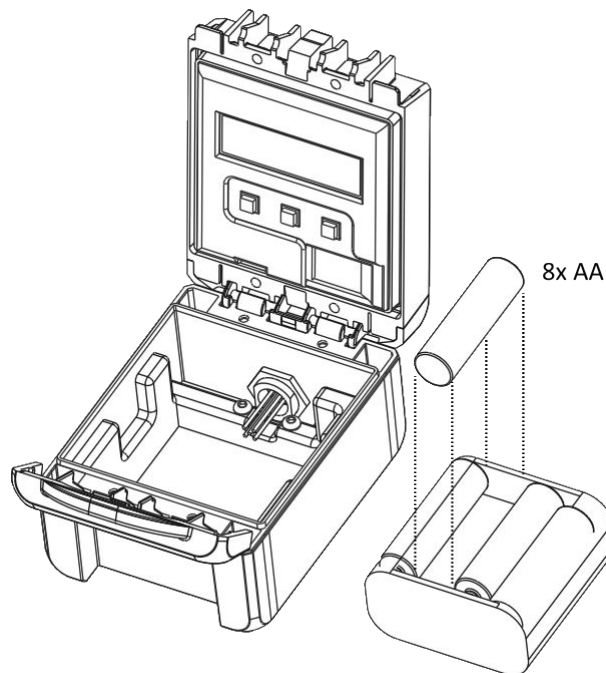

1. Open the case cover. Make sure that the device is turned off
2. Remove the battery holder carefully, without pulling on the cable.
3. Insert 8x AA batteries into the battery holder as indicated. Battery polarity \oplus/\ominus must be followed.
4. Place back the battery holder into the device and place the cable inside the device, so that it does not get pinched.



Batteries may become hot: Be careful as the device or batteries may become hot when used continuously for a long period of time.



Remove battery: Turn off the device before removing the batteries. Otherwise the data may become corrupted and/or the SD card may be damaged.



Handle batteries with care: Wipe the electrodes of the batteries with a soft dry cloth before inserting. Remove the batteries when you will not use the device for a long time. The batteries may leak and damage the device if left installed during prolonged periods of non-use. Store the batteries in a location where the temperature will remain at or below room temperature. Avoid locations with high temperatures.

3.2 Inserting/Removing Battery (BATLOGGER A+)

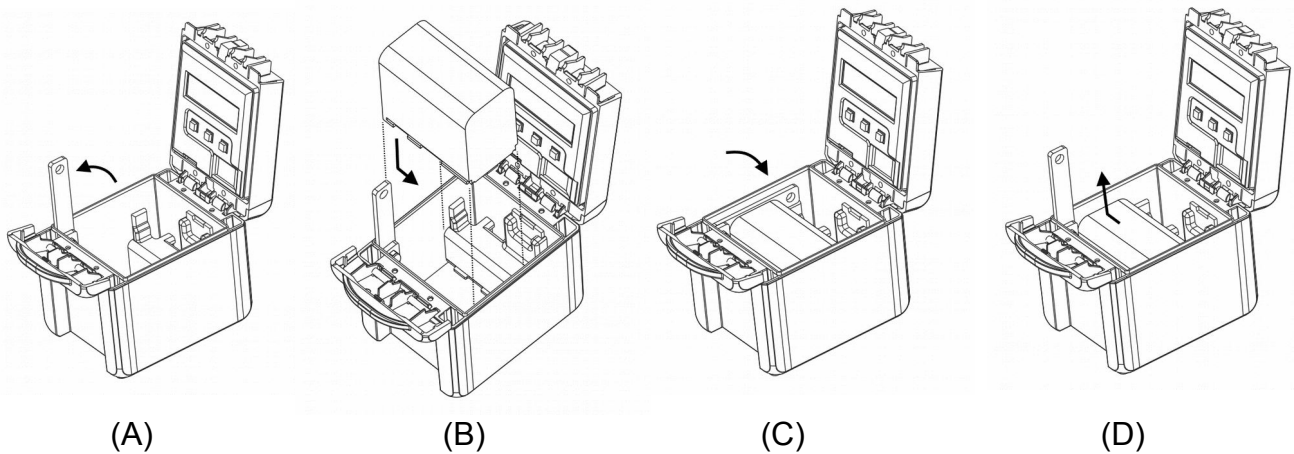

1. Open the case cover. Make sure that the device is turned off
2. Lift the safety lever until it is perpendicular (A).
3. Insert the battery as indicated above (B) on the far left and then slide to the right edge of the case.
4. Close the safety lever to lock the battery (C).
5. To remove the battery, lift the safety lever until it is perpendicular (A). Then slide the battery to the left edge of the case and remove it (D).



Batteries may become hot: Be careful as the device or battery may become hot when used continuously for a long period of time.



Remove battery: Turn off the device before removing the battery. Otherwise the data may become corrupted and/or the SD card may be damaged.



Handle battery with care: Wipe the electrodes of the battery with a soft dry cloth before inserting. Remove the battery when you will not use the device for a long time. The battery may leak and damage the device if left installed during prolonged periods of non-use. If the removed battery will not be used for six months or longer, charge the battery for about 30 minutes before storing it, and after that, recharge the battery every six to twelve months. Store the battery in a location where the temperature will remain at or below room temperature. Avoid locations with high temperatures.

3.2.1 Battery charging

Upon delivery the battery of the device may not be fully charged. Please charge the battery before first use.

Use the included charger to charge the battery. Follow the separate instructions of the charger.

3.3 Adjusting parameters and settings

Basically the device can be used directly with factory settings. For some applications such as interval recording, parameters must be adapted accordingly.

Ideally, adjusting parameters should take place before use, directly on a PC or Mac. See chapter 8.2 and 9.4 for detailed information about parameters and settings.

1. Insert the supplied SD card into the memory card reader of your computer and start the BATPARS editor software directly from the SD card.



2. Open the file "BATAPARS.xml" which is stored in the root directory of the SD card by clicking the "Open..." button.

3. Change parameters as needed.
e.g. set capture time frame (schedule) for long-term monitoring and directly check programmed times in advance.

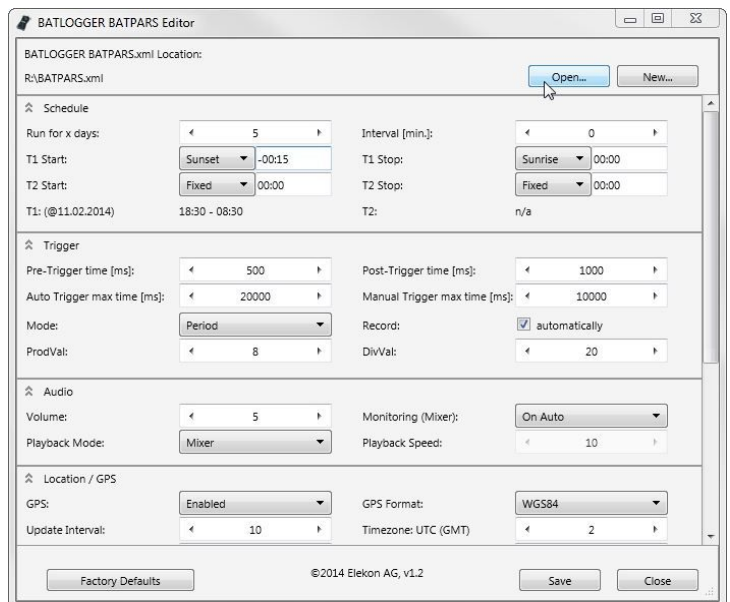

4. Save the parameter file by clicking *Save*. The parameters are now on the SD card.

5. Close the BATPARS editor software with "Close".

6. Insert the SD card now in the device. The parameters are now loaded at start-up.

3.4 Connect and install the microphone

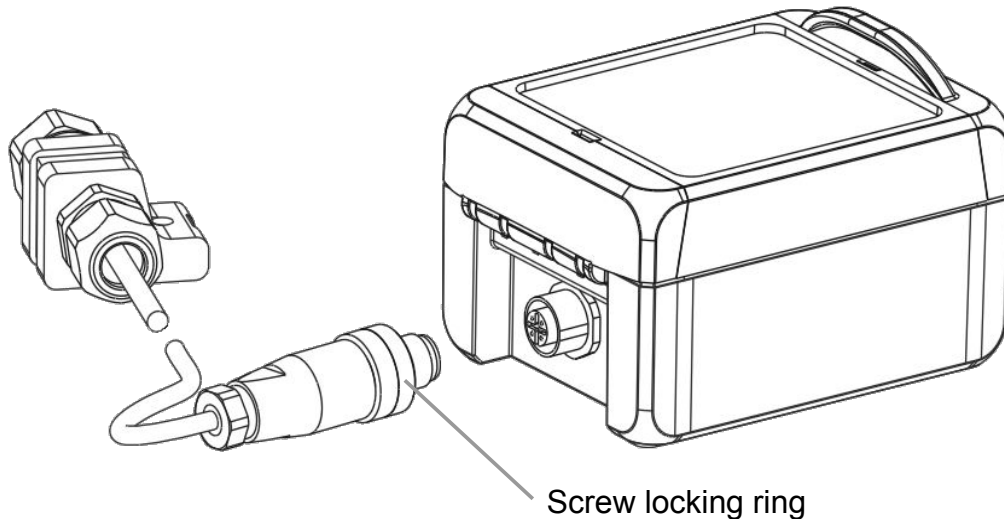

1. Plug in the connector by arranging the clip of the plug to the notch of the socket.
2. Turn the screw locking ring clockwise to tighten the connector until it is fully inserted.

The microphone can be placed independently from the device to ensure optimal acoustic reception, while allowing an inconspicuously placement.

To increase the life of your microphone, it should always be mounted with the opening facing ground up to a maximum horizontal position to prevent moisture accumulation inside. Use a tripod or similar to easily mount and direct the microphone as needed.

Also consider the surroundings of the microphone. Close objects or surfaces may reflect sound and distort recorded bat calls.



Microphone mounting: To properly place the microphone, use the tripod socket, the included strap or similar to mount it to sturdy object (tripod, post, branch, etc.).

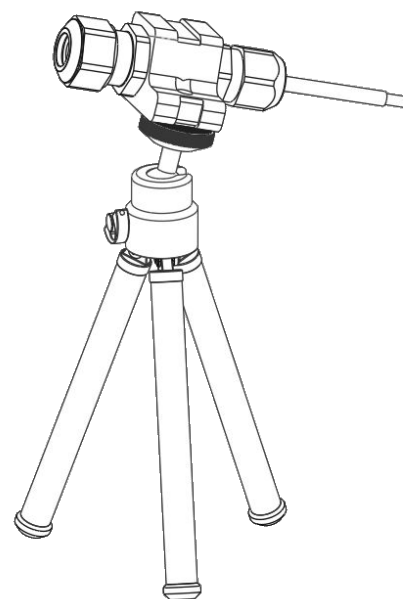
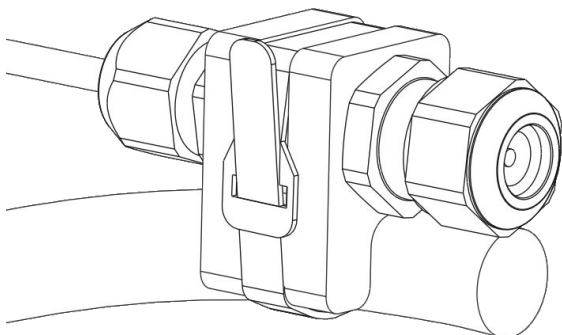

3.5 Close and secure the device

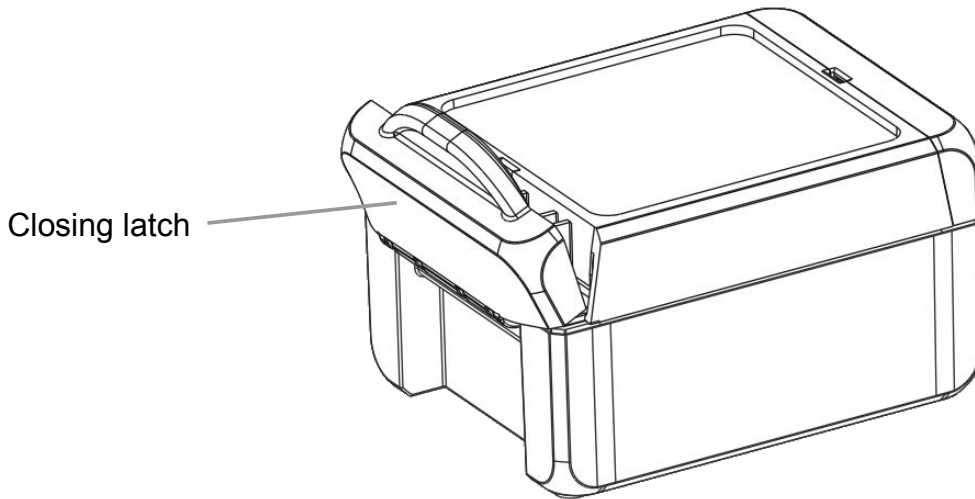

When using the device in the field, the cover must be closed tightly and the external connectors must be mounted correctly to protect the device from dust and water. Close the latch until you hear a “click”.



Ensure tightness: Make sure that there is no dirt between the cover and housing that could affect tightness. If necessary, clean the sealing with a lint-free, slightly dampened cloth. Internal moisture can lead to short circuits and damage the unit or even cause a fire.



Avoid temperature fluctuations: The device must be protected from direct sunlight and extreme cold in order to avoid extreme temperature fluctuations that could affect tightness. Place the device in a shady place. Optionally, a dehumidifying agent can be used to prevent condensation inside the unit.



Secure the device: The device must be properly installed and secured. In particular, it must be ensured that during operation it can not come loose or fall down and that no people or animals can be injured.

4 General handling and operation

4.1 Inserting/Removing SD Card

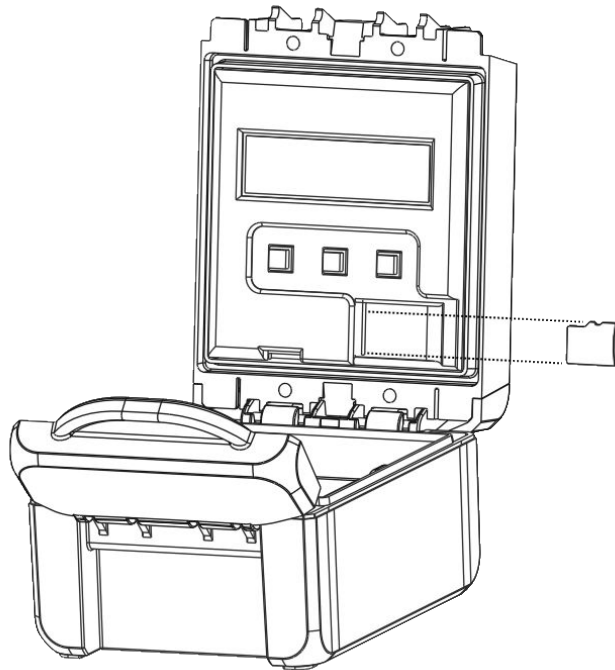

1. Open the case cover. Make sure that the device is turned off
2. Place the SD card in the cavity with the card label facing toward you. Slide it to the left and insert it all the way into the SD card slot.
3. Push the SD card to the left to unlock it and then slide it to the right to remove.



Remove SD card: Turn off the device before removing the SD card. Otherwise the data may become corrupted and/or the SD card may be damaged.

4.2 Turn on the device

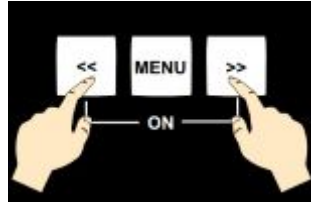

Press both keys `<<` and `>>` simultaneously to turn on the device.

```
BATLOGGER A
<< Power-On >>
```

Device powers up, keep both keys `<<` and `>>` pressed.

```
BATLOGGER A
#1234 FW2.4
Elekon AG ^o^
```

Serial number and software version are indicated on the display.

```
Initializing
SD Card
```

The SD/SDHC card is initialised.

```
Using Parameters
from SD Card
```

Parameters are loaded from "BATAPARS.XML" file. See also chapter 3.3.

```
01.04.2015 18:59
25°C SD: 14% ■
Start Record >
```

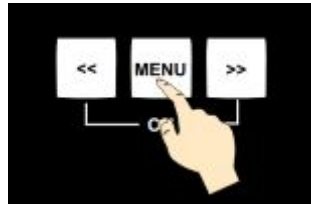

Device is ready. The main menu is active.
The first line displays the device date/time.
The second line displays the temperature, the used SD card space and the battery status.

4.3 Main menu





Press the  key to change between the menu entries.



```
01.04.2015 18:59
25°C SD: 14% ■
Start Record? >
```

Press  key to enter “Recording mode”. See chapter 5.
Press  key to proceed to the next menu item.



```
01.04.2015 18:59
25°C SD: 14% ■
Test Record? >
```

Press  key to enter “Test Recording mode”. See chapter 5.
Press  key to proceed to the next menu item.



```
01.04.2015 18:59
25°C SD: 14% ■
Process File? >
```

Press  key to enter “Process File” menu. See chapter 6.
Press  key to proceed to the next menu item.

```
01.04.2015 18:59
25°C SD: 14% ■
Setup? >
```

Press  key to enter “Setup” mode. See chapter 8.
Press  key to proceed to the next menu item.

```
01.04.2015 18:59
25°C SD: 14% ■
Shut Off? >
```

Press  key to shut-down the device.
Press  key to proceed to the first menu item.

Automatic shut-off:



If no keys are pressed for 4 minutes, and the device is not in recording or sleep mode, it will switch off automatically.

4.4 Device lock (Theft protection)

The device lock can be used to prevent manipulations on a running unattended device or to leave the device unusable and thus unattractive for possible thieves. For this, a user definable PIN (Personal Identification Number) can be configured (see chapter 8.2.6).

If device lock is enabled, on device start-up or manual wakeup, the correct PIN must be entered before the device can be used.

```
Enter device PIN  
<0>
```

Use the keys  or  to change the digit between “<” “>”.
Press  key to switch to the next digit or to delete the digit on the left with <←>.

```
Enter device PIN  
0000<↓>
```

Press  key to enter the PIN with <↓>.

When the correct PIN was entered, the device will start up as usual.

When an incorrect PIN was entered, the device will turn off. After 5 incorrect attempts, the device is blocked and needs to be unblocked with the PUK (Personal unblock key). Contact Elekon AG to get the PUK.

5 Record bat calls

For long term passive monitoring, the device usually only operates during the night and “sleeps” during the day to save battery power and SD card space (delayed recording).

It is also possible to immediately start record mode to test the installation or to use the device for active monitoring by executing the “Test record” function in the main menu.

5.1 Delayed recording (Recording in time frames)

One or two operation time frames can be configured.

During the operation time (record mode), the device detects and records bat calls depending on the recording and trigger settings (see below).

During the sleep time (sleep mode), the device goes into power saving mode and turns off any peripherals. It will only wakeup if aborted by the user.

The time frames can be configured flexibly. The times can also be set dynamically by the position of the sun (sunrise and sunset). The device date/time and location must be configured correctly in order that the dynamic times are calculated accurately (see also chapter 8.2).

Example:

- Nr. Days = 2
- T1 Start = 20:30 (Sunset) T1 Stop = 01:30
- T2 Start = 04:00 T2 Stop = 07:30 (Sunrise + 15min)

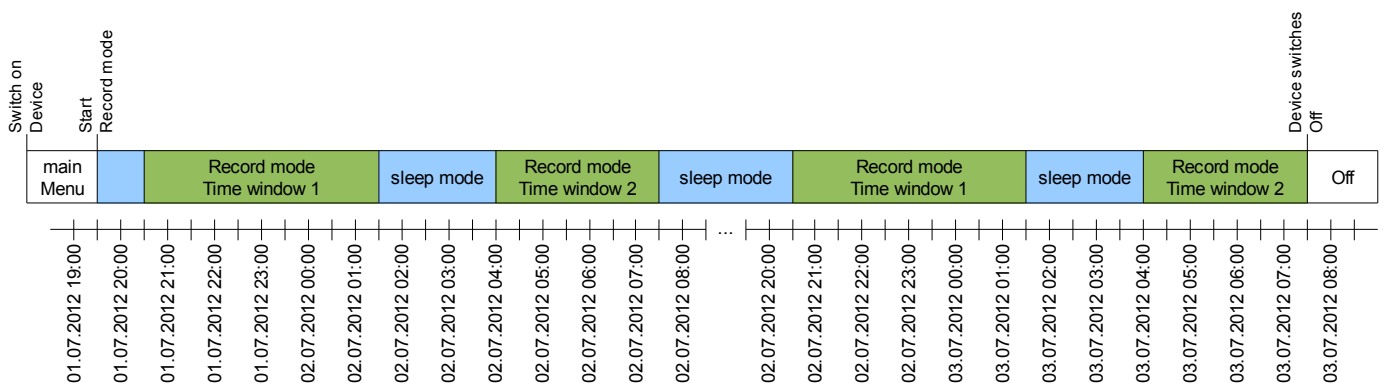

When starting delayed recording, the device checks its status depending on the configured features before changing to record or sleep mode:

- Microphone connection
- Trigger

```
Mic possibly
damaged!
Continue? >
```

If the microphone or its connection is not installed correctly or damaged:

Press  key to start recording anyway.

Press  key to abort.

```
Manual mode set!
Start anyway? >
```

If manual trigger mode is configured:

Press  key to start recording anyway.

Press  key to abort.

When time frame start time has not passed yet, the device displays the programmed schedule and then enters sleep mode:

```
Delayed rec:  
T1 20:15-08:30  
T2 00:00-00:00
```

Programmed time frames are displayed.

```
Sleeping:  
15:32 - 20:15  
next: Rec T1
```

The device is now in sleep mode.
Press key to wakeup the device, abort delayed recording and exit to main menu.

When a time frame start time has passed, the device will wakeup and start recording mode.
When a time frame stop time has passed, the device will go back to sleep mode.

5.2 Record mode

The device can be operated in different ways.



In **automatic recording** the signal from the microphone is constantly monitored and the recording started automatically, when a triggering event is registered (detected ultrasound signal, e.g. bat call). The duration of such recordings depends on the presence of the triggering criteria. The default setting allow for a recording duration which includes 0.5 seconds before the first and 1 second after the last trigger event (pre- and post-trigger). With the default settings, the shortest recording duration is therefore 1.5 seconds, which corresponds to roughly 1 MB of data on the SD card.

If the device is set for **continuous recording**, the RAM is filled with data and thereafter data are written to the memory card. As the loggers RAM is limited to 32 MB, the length of a single recording sequence can not exceed approx. 53 seconds, but can be set to less. Subsequently this recording sequence will be written as #****.wav file to the SD card and a new recording will start, thereby overwriting data in RAM. The time required for data storage to the memory card is largely depending on the file size but also on the type of card. In general the writing of the file should require significantly less time than the recording itself.

In **manual recording** the triggering has to be performed through the key pad and may also be stopped this way. If a manual stop does not occur, the recording will stop automatically after a user selectable manual trigger time (default = 10 sec), and the #****.wav file be written to memory card.

In record mode, the device displays date/time, temperature, number of recordings, SD card space used and battery status. The following functions can be executed:

```
01.04.2015 20:31
25°C SD: 14% ■
Sampling... ^5^
```

Press  key to manually start a recording. Press  key again to stop it.

Press  key to proceed to the next menu item.

```
01.04.2015 20:53
25°C #25 15% ■
Exit Record? >
```

Press  key to exit record mode.

Press  key to proceed to the next menu item.

```
01.04.2015 20:54
25°C #27 15% ■
LR:xxxxxxxx.wav>
```

The file name of the last recording is displayed.

Press  key to load the “Process File” menu with the last recording selected. it can then directly be processed, e.g. deleted, etc. See also chapter 6.

After leaving “Process File” menu, record mode is continued.

Press  key to proceed to the first menu item.

When an automatic trigger is configured (default), the device records bat calls automatically:

```
01.04.2015 20:54
25°C #27 15% ■
Sampling... ^5^
```

The device is listening for bat calls (triggers). The current crest factor is displayed (^5^) if a crest trigger is used.

```
Activity:
Freq 32 kHz
Recording...
```

If the trigger condition is met, a new recording is started automatically. The recording stops, when the trigger condition is not met any more during at least the post trigger time.

```
Saving...
xxxxxxxx.wav
Freq = 32kHz
```

The recording is now saved to the SD card. The file name and detected peak frequency is displayed. After that, listening continues.

5.3 Trigger modes

There are different approaches to detect bat calls. As the nature is not predictable, none of them is perfect. The difficulty lies in the distinction between signal (bat calls) and unwanted noise. Different algorithms are implemented and can be selected to automatically trigger recordings. Depending on the recording location (e.g. noisy environment, insects, etc.) and operation purpose (e.g. passive or active monitoring, etc.), it may be good to use different trigger modes and/or trigger settings.

5.3.1 CrestAdvanced trigger

Responds to all loud, narrow noises like bat calls, sensitivity to disturbing noise minimized. Very sensitive, detects even very quiet respectively far away calls. Sensitivity and frequency bounds can be adjusted. Responds to any loud, narrow-band sound, e.g. to technical sounds and insects.

5.3.2 Crest trigger

Responds to all loud, narrow noises like bat calls, but also technical noise and insects. Very sensitive, detects even very quiet respectively far away calls. Sensitivity and lowest frequency can be adjusted. Responds to any loud, narrow-band sound, e.g. to technical sounds and insects.

5.3.3 Period trigger

The difference in sound production of bats (vocal cords) and insects (stridulation) affects the continuity period. The trigger period takes advantage of this. Insects (grasshoppers, crickets) do not trigger or only very rarely but low frequency bats may not be identified.

5.4 Interval recording (Record in time intervals)

As with time delayed recording, time frames have to be defined and a number of days must be set. When also a recording interval is entered, then the device switches to record mode at the start time, but only for a single recording or max. for one minute.

Then further recordings are blocked for the programmed number of minutes ("RecIntvl" / default = 0 = off). This is followed by another record mode. This interval operation continues to the end of the time frame. For this interval operation the various trigger modes can be used.

Example:

- Rec Intervall = 3

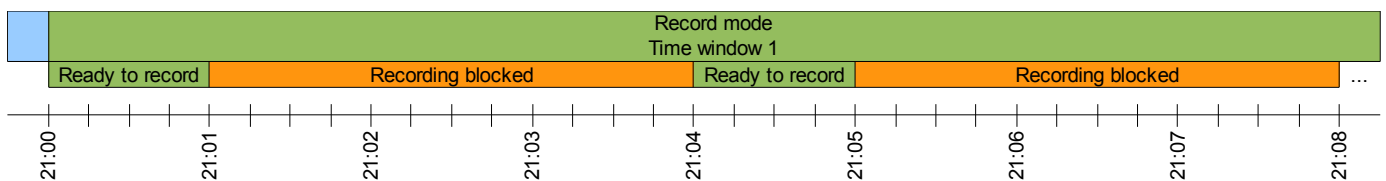

6 Process recordings

For immediate control, stored audio files can be reviewed. Recording details such as date, time, length, peak frequency and more can be displayed.

Single recordings on the memory card can also be erased through this mode. Erasing the complete memory card must be achieved by formatting it (Settings menu).



6.1 Select folder

Depending on the settings, the recordings are stored in folders on the SD card. Per default, every night a new folder will be used:



- BL20150401
 - 12340001.wav
 - 12340002.wav
- BL20150402
 - 12340001.wav
 - 12340002.wav
 - 12340003.wav
- BL20150403
 - 12340001.wav
- ...

To process a recording, first select the folder:



```
Process
Select folder:
BL20150403 <>
```

Press  key to select the previous folder.
Press  key to select the next folder.
Press  key to proceed to the next menu item.



```
Process
Fold: BL20150403
Open folder? >
```

Press  key to open the selected folder and proceed to select and process a recording file. See chapter 6.2.
Press  key to proceed to the next menu item.

```
Process
Fold: BL20150403
Delete folder? >
```

Press  key to delete the selected folder and all its content. See chapter 6.1.1.
Press  key to proceed to the next menu item.

```
Process
Exit Process? >
```



Press  key to exit process menu.
Press  key to proceed to the first menu item.

When no folders are used or present, the select folder menu is skipped and the select file menu is displayed.

6.1.1 Delete folder

CAUTION: All data in the folder will be deleted.



```
Delete folder?
<< >> to confirm
```

Press both keys  and  simultaneously to confirm deletion.
Press  key to cancel.



6.2 Select recording file

To process a recording, select the recording file (wav):



```
Process
Sel File (54):
12340001.wav <>
```

Press  key to select the previous recording file.
Press  key to select the next recording file.
Press  key to proceed to the next menu item.



```
Process
File: #12340001
Analyse? >
```

Press  key to analyse the selected recording file. See chapter 6.2.1.
Press  key to proceed to the next menu item.

```
Process
File: #12340001
Delete? >
```

Press  key to deleted the selected recording file. See chapter 6.2.2.
Press  key to proceed to the next menu item.



```
Process
Exit Process? >
```

Press  key to exit process menu.
Press  key to proceed to the first menu item.



6.2.1 Analyse recording

The metadata of the selected recording file is loaded and displayed:



```
File: #12340001
03.04.2015
20:34:46 <>
```

Press  key to show previous data screen.
Press  key to show next data screen.
Press  key to go to the last menu item.



```
File: #12340001
Dur = 4 s
Peak = 40 kHz <>
```

Press  key to show previous data screen.
Press  key to show next data screen.
Press  key to go to the last menu item.

```
File: #12340001
Temp = 10 °C <>
```

Press  key to show previous data screen.
Press  key to show next data.
Press  key to go to the last menu item.



```
Process
File: #12340001
Exit Analyse? >
```

Press  key to exit analyse menu.
Press  key to show first data screen.

6.2.2 Delete recording

CAUTION: The recording (wav) and its metadata (xml) will be deleted.

```
Delete file?
<< >> to confirm
```

Press both keys  and  simultaneously to confirm deletion.
Press  key to cancel.

After deletion, a new recording file can be selected. See chapter 6.2.

7 Recording location

Each recording is geotagged with the coordinates of the recording location. The current location must be set before starting recording mode (see chapter 8.2). The location is also used to calculate sunset/sunrise times for delayed recording.

Please use the BATPARS Editor software to easily select the location on a map.

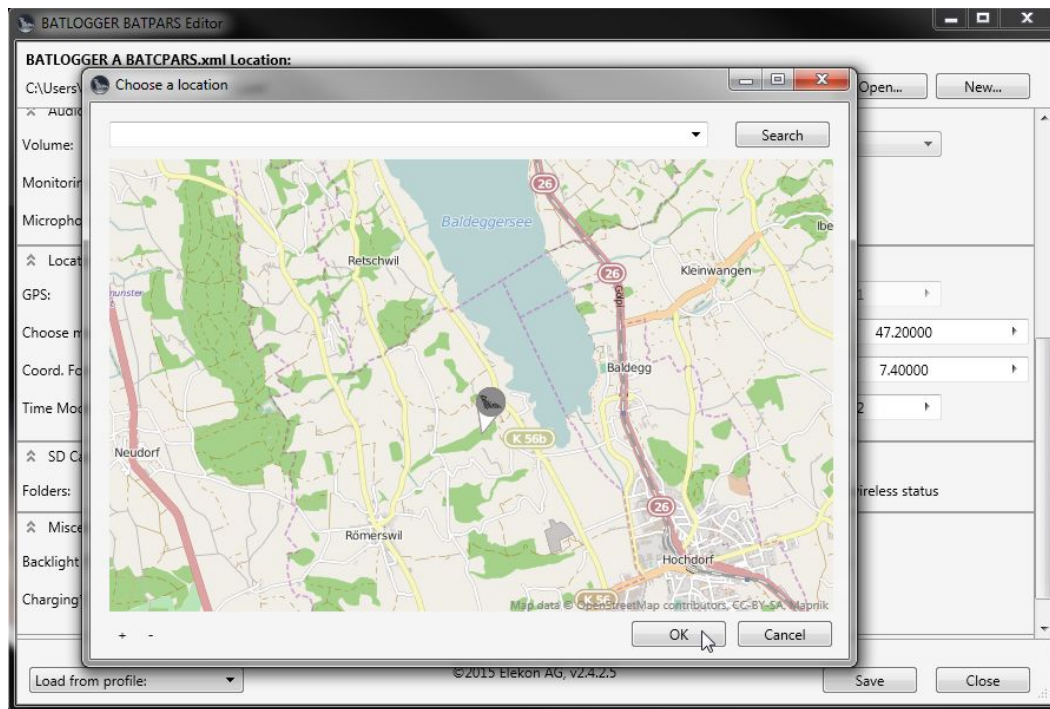

8 Setup (Settings)



The device can be configured to fit different needs. Parameters of functions like recording time frames (delays), triggers, audio, time zone, SD card and more can be changed in the setup menu.

Most settings can be changed both directly on the device as well as with the BATPARS Editor software on your computer (see also section 3.3). Some settings can only be carried out on the device itself (e.g. set time). Others can only be made with the BATPARS Editor software (e.g. pre-trigger settings).



8.1 Operation

The setup menu is structured in various sub-menus. The structure is described in chapter 8.2. The general operation and navigation is as follows:



```
Setup X/Z
Submenu X >
```

Press  key to go to the last menu item.
Press  key to enter the sub-menu X.
Press  key to go to the next menu item.





```
Setup Y/Z
Submenu Y >
```

Press  key to go to the last menu item.
Press  key to enter the sub-menu Y.
Press  key to go to the next menu item.



```
Submenu Y
Parameter A
ON <>
```

Use the keys  or  to change the value.
Press  key to go to the last menu item.



```
Submenu Y
Parameter B
Value = 1<2>.3
```

For larger number values (e.g. coordinates) single digits can be increased/decreased
Use the keys  or  to change the digit between “<” “>”.
Press  key to switch to the next digit, to delete the digit on the left with  or to enter the value with .

```
Setup Y/Z
Function >
```

Press  key to execute the function.
Press  key to go to the next menu item.

```
Setup Z/Z
Exit Setup? >
```

Press  key to exit (sub-)menu.
Press  key to show first menu item.

8.2 Setup-Menu

8.2.1 Setup 1/7: Delay Record

See also chapter 5.1.

Menu / Parameter	Description	Default
Setup 1/7 Delay Record	Timing (delay) of the recordings (Program 1 or 2 time slots per day for a programmed number of days)	
Nr. Days	Enter the number of days (0..999) on which the time frames (one or both) are performed. 0 = time control (delay) disabled Example: 30 For a maximum of 30 days, recording is performed during the configured time slot (see below)	3
T1 Start Mode	Mode 1. start time 0 = Fixed: Fixed time 1 = Sunset: Time of sunset at location of LOC_LAT/LOC_LON of the respective day 2 = Sunrise: Time of sunrise at location of LOC_LAT/LOC_LON of the respective day	1
T1 Start	1. start time Depending on the mode: time or difference (in 15 minute steps) Example: Fixed 20:30 Start 1. time frame at 20:30	00:00
T1 Stop Mode	Mode 1. stop time 0 = Fixed: Fixed time 1 = Sunset: Time of sunset at location of LOC_LAT/LOC_LON of the respective day 2 = Sunrise: Time of sunrise at location of LOC_LAT/LOC_LON of the respective day	2
T1 Stop	1. stop time Depending on the mode: time or difference (in 15 minute steps)	00:00

	Example: Fixed 01:00 Stop 1. time frame at 01:00	
T2 Start Mode	Mode 2. start time 0 = Fixed: Fixed time 1 = Sunset: Time of sunset at location of LOC_LAT/LOC_LON of the respective day 2 = Sunrise: Time of sunrise at location of LOC_LAT/LOC_LON of the respective day	0
T2 Start	2. start time Depending on the mode: time or difference (in 15 minute steps) Fixed 00:00 = 2. time slot disabled Example: Sunrise -02:30 Start 2. time frame 2:30h before sunrise	00:00
T2 Stop Mode	Mode 2. stop time 0 = Fixed: Fixed time 1 = Sunset: Time of sunset at location of LOC_LAT/LOC_LON of the respective day 2 = Sunrise: Time of sunrise at location of LOC_LAT/LOC_LON of the respective day	0
T2 Stop	2. stop time Depending on the mode: time or difference (in 15 minute steps) Fixed 00:00 = 2. time slot disabled Example: Sunrise +00:30 Stop 2. time frame 30min after sunrise	00:00
Rec Intervall	Interval time between single recordings (in one minute steps) Example: 3 After a recording at least 3 minutes no new recording is started (triggered)	0

8.2.2 Setup 2/7: Trigger

See also chapter 5.3.

Menu / Parameter		Description	Default	
Setup 2/7 Trigger	Trigger settings Set the trigger mode, that is how a recording is started			
	TRIG_MODE	<p><i>Choose trigger mode:</i></p> <p>0 = Manual: start and stop recording need manual key input (autom. stop after "MANTRIG MAXTIME")</p> <p>1 = Continuous: continuous recording of blocks of default 53 seconds duration (interrupt for storage).</p> <p>2 = Crest Adv: automatic triggering with Crest factor, enhanced call detection and reduce noise sensitivity (manual triggering possible to override automatism)</p> <p>3 = Crest: automatic triggering with Crest factor (manual triggering possible to override automatism)</p> <p>4 = Period: automatic triggering with Period algorithm (manual triggering possible to override automatism)</p>	2	
	TRIG_AUTOREC	<p>0 = Manual: A trigger event does not start recording. The recording must be started and stopped manually, but the trigger frequency is displayed.</p> <p>1 = Auto: A trigger event automatically starts the recording and recording automatically stops when trigger conditions are no longer met.</p>	1	
	TRIG_MODE: Crest Adv	Min. Crest	Minimal Crest factor as trigger condition Lower values trigger easier	7
		Min. F	Minimal frequency for trigger condition in kHz	15
		Max. F	Maximal frequency for trigger condition in kHz	155
	TRIG_MODE: Crest	Min. Crest	Minimal Crest factor as trigger condition Lower values trigger easier	6
		Min. RMS	Factor for minimal effective value as trigger condition Lower values trigger easier	2
		Min. Peak	Factor for minimal amplitude as trigger condition Lower values trigger easier	2
		HP	Factor for the lowest frequency, that still may elicit a trigger event (Factor times 1,22 kHz)	6

TRIG_MODE: Period	ProdVal	Period-Trigger: ProdVal Higher values improve triggering at low frequencies, but also insects, and vice versa.	8
	DivVal	Period-Trigger: DivVal Higher values improve triggering at low frequencies, but also insects, and vice versa.	20
PRETRIG_TIME_MS (only changeable via BATPARS.XML)		Pre-trigger length in ms 0..5000 Length ahead of the trigger event that is saved from the buffer to the recording file.	500
POSTTRIG_TIME_MS (only changeable via BATPARS.XML)		Post-trigger length for automatically triggered recordings in ms 0..10000 If no trigger event is detected during this time, the recording will be stopped.	1000
AUTOTRIG_MAXTIME_MS (only changeable via BATPARS.XML)		Maximal length for automatically triggered recordings in ms 0..535000 The recording is stopped when reaching maximal length even trigger event are detected.	20000
MANTRIG_MAXTIME_MS (only changeable via BATPARS.XML)		Maximal length for manually triggered recordings in ms 0..535000 The recording is stopped when reaching maximal length even if the stop key () is not pressed.	10000
TRIG_NRBLOCKS (only changeable via BATPARS.XML)		Number of blocks that must meet trigger criteria in order to trigger 1..10	2

8.2.3 Setup 3/7: Audio

<i>Menu / Parameter</i>		<i>Description</i>	<i>Default</i>
Setup 3/7 Audio		Audio settings	
	Microphone-test mode	Mode used when "Test Microphone" function is executed. 0 = Manual: Record the current (silent) spectrum and write it to the log file 1 = Automatic See MC32 manual	0
	Test Microphone	Execute microphone test with selected mode (see above)	

8.2.4 Setup 4/7: Location

See also chapter 7.

<i>Menu / Parameter</i>		<i>Description</i>	<i>Default</i>
Setup 4/7 Location		Position settings	
	Coord.Fmt	Coordinates display format to display current location 0 = WGS84: (e.g.. 47.052804 / 8.257801) 1 = CH1903: (e.g.. 662240 / 211632)	0
	TZ	Set time zone Deviation to UTC in hours Example: +2 Daylight savings time in Zurich (CH)	+2
	Set manual location	Enter manual location (coordinates) This location is used: <ul style="list-style-type: none"> To calculate sunset and sunrise As recording position 	
		LOC_LAT	Latitude, in WGS84 or CH1903 (dep. Coord. Fmt)
	LOC_LON	Longitude, in WGS84 or CH1903 (dep. Coord. Fmt)	7.4

8.2.5 Setup 5/7: SD card

See also chapter 2.4.

<i>Menu / Parameter</i>	<i>Description</i>	<i>Default</i>
Setup 5/7 SD Card	SD card setup	
Folder_MODE	<p>Store recording in folders</p> <p>0 = None: No folders used, all data is stored in the root folder of the SD card</p> <p>1 = Daily: Use a new folder daily (12:00 – 12:00): BLYyyyymmdd</p> <p>2 = Weekly: Use a new folder weekly (Mo 12:00 – Mo 12:00): BLYyyWww</p> <p>3 = Monthly: Use a new folder monthly (1. 12:00 – 1. 12:00): Blyyyymm</p> <p>Example: 1 Recordings (WAV, XML, GPX, KMZ) are stored into a separate folder each night Folder “BL20130802” contains data of the night from 2. to the 3. August 2013 Folder “BL20130803” contains data of the night from 3. to the 4. August 2013 etc. The folder is changed each day at noon (12:00)</p>	0
STATUS_MODE	<p>BLWiFi status</p> <p>0 = Off: Disabled</p> <p>1 = On: Enabled, BLWiFi can display the actual state if a connection is established</p>	0
Write BATPARS	Write the current settings to the BATPARS.XML file	
Delete BATPARS	Delete the BATPARS.XML file from the SD card	
Format SD Card	<p>Format the SD card</p> <p>Delete all recordings, meta-data and files from the SD card. Only BATPARS.XML and BATREC.LOG files will not be deleted.</p> <p>CAUTION: All data on the SD card will be deleted. Make sure that you have made a backup.</p>	
Test SD Card		

8.2.6 Setup 6/7: Miscellaneous

Menu / Parameter		Description	Default	
Setup 6/7 Miscellaneous		Various settings		
	Set Date/Time		Set date and time	
		TIMEMODE	0 = Manual: Date and time can be set manually	0
	Device Lock (Theft protection)		Change device lock mode and PIN	
		Device Lock Mode	Off: Device is always operable On: Device is operable only after entering correct PIN (see also chapter 4.4)	Off
		Device PIN	PIN (Personal Identification Number) can be freely selected by the user and must be 4..6 digits. PIN must be confirmed by entering it again. ATTENTION: Write the PIN down and keep it in a secret and secure place. If the PIN is lost, the device must be unblocked with the PUK. Contact Elekon AG to get the PUK.	
Load Defaults		Set settings back to factory defaults		
SETUP_DISABLED (only changeable via BATAPARS.XML)		Disable setup menu 0 = Setup menu is accessible 1 = Setup menu is locked, no configuration changes can be done on the device	0	

8.2.7 Setup 7/7: Exit setup

<i>Menu / Parameter</i>	<i>Description</i>	<i>Default</i>
Setup 7/7 Exit Setup	Exit Setup menu and save changes	
Save to BATAPARS	Write settings to BATAPARS.XML file and exit Setup menu	
Save to int.Mem	Write settings to internal memory and exit Setup menu If the BATAPARS.XML file exists on the SD card, those settings will be loaded on the next start of the device.	
Discard changes	Discard changes and exit Setup menu	

9 Recordings and Files

9.1 The audio data file "xxxxxxx.wav"

After completion of recording into internal RAM, the stored data is written as standard audio WAVE file onto the inserted SD card with the file name "xxxxxxx.wav". (e.g. 10160435.wav) The first four digits identify the serial number of the device and the following four digits exhibit the consecutive number of the recorded files on the inserted SD card. The above example therefore identifies the 435th recording on this SD card of the device with the serial number 1016.

The *.wav file contains all the uncompressed raw measurement values of the analogue to digital converter and a "header", which is specific to the wave format. This "header" contains, amongst other information, the sampling rate of the digitiser.

Concurrent with these recorded wave data, a file containing meta information about the recording (see below) is saved to SD card with the name *.xml (in our example 10160435.xml).

The recordings can optionally be stored into sub-folders (daily, weekly, monthly). See also chapter 8.2.5.

The standard *.wav files can be read and opened with general audio software or bat specific sound analysis programs. It may be displayed as time signal or spectrogram. The latter offers best possibilities to identify species.

Elekon AG offers a specific analysis software for Windows PCs: **BatExplorer**. It can be found on the included SD card or can be downloaded from www.batlogger.com.

[WSL](http://www.wsl.ch) offers **BatScope**, a Mac software tool for management and preview of recorded data, which will eventually be extended to bat species identification: see <http://www.wsl.ch/fe/biodiversitaet/produkte/batscope/> or bats@wsl.ch

9.2 Meta data file "xxxxxxx.xml"

With every saved recording "xxxxxxx.wav" audio file, an additional information file "xxxxxxx.xml" (e.g. 10160435.xml) is saved, following the same numbering convention, and containing various meta information on recording time, date, location, temperature and device parameter settings.

Example of the content of an *.xml meta information file:

```
<BatRecord>
  <Firmware>2.4</Firmware>
  <SN>1016</SN>
  <Filename>10160435.wav</Filename>
  <DateTime>28.04.2010 21:31:29</DateTime>
  <Duration>2 Sec</Duration>
  <Samplerate>312500 Hz</Samplerate>
  <Temperature>26 C</Temperature>
  <BattVoltage>8.92 V</BattVoltage>
  <GPS>
    <Valid>>manual</Valid>
    <Position>47.056358 8.251432</Position>
    <CH1903>661752/212022</CH1903>
  </GPS>
  <Trigger>
    <TRIG_MODE>Crest</TRIG_MODE>
    <Version>V1.0</Version>
    <Event>AutoTriggerd</Event>
    <PRETRIG_TIME_MS>500</PRETRIG_TIME_MS>
    <POSTTRIG_TIME_MS>1000</POSTTRIG_TIME_MS>
    <TRIG_PAR0>6</TRIG_PAR0>
    <TRIG_PAR1>2</TRIG_PAR1>
    <TRIG_PAR2>2</TRIG_PAR2>
    <TRIG_PAR3>12</TRIG_PAR3>
    <TrigValue0>6</TrigValue0>
    <TrigValue1>40</TrigValue1>
    <TrigValue2>263</TrigValue2>
    <TrigValue3>44</TrigValue3>
  </Trigger>
</BatRecord>
```

The .xml info file contains the following information:

The firmware of the device was version 2.4
The device number was 1016 (Serial Number)
The accompanying WAVE file is "10160435.wav"
The recording happened on April, 28. 2010 at 21:31:29
The recording duration is 2 seconds
The sampling rate was 312500 samples per second
The temperature when recording was 26° C
The battery voltage amounted to 8.92 V

Location is set manually
Lat.- & longitude of the rec. position in degrees (WGS84)
The Swiss coordinates are 661752 / 212022 m (CH1903)

The trigger mode was set to "Crest"
The version of the triggering algorithm was V1.0
The triggering was automatic, thus with the Crest routine
Before the first trigger occurred, 0.5 s were recorded
After the last trigger event, 1 s was additionally recorded
The parameter "min.Crest" was set to 6
The parameter "min.RMS" was set to 2
The parameter "min.Peak" was set to 2
Trigger cutoff freq. was set to > than 12x1.22kHz=15 kHz
Triggering Value of parameter TRIG_PAR0
Triggering Value of parameter TRIG_PAR1
Triggering Value of parameter TRIG_PAR2
Triggering Value of parameter TRIG_PAR3

9.3 Log file "BATREC.log"

When in use, the device automatically writes a log file "BATREC.log" in text format to the SD card. Every text line is preceded by the serial number (SN) of the device writing the log. In the file "BATREC.log", all activities of the device are listed chronologically. Events like starting up or shutting down are logged accurate to the minute, while logging of the normal recording activity only happens every hour.

Example BATREC.log:

SN2123 07.04.2015 19:25:10? - power on (SWRev=2.4, HWRev=B3)	Device #1021 was switched on
SN2123 07.04.2015 19:25:16 - Schedule: T1 20:15 - 07:00	Delayed record schedule
SN2123 07.04.2015 19:25:18 - record mode started	Record mode was started by the user
SN2123 07.04.2015 19:25:20 - sleeping until 20:15 ...	Device is in sleep mode
SN2123 07.04.2015 20:15:01 - Idle: #R=0, T[°C]=24, VB[V]=10.36	Device status after wakeup
SN2123 07.04.2015 20:15:01 - sampling T1 until 07:00 ...	
SN2123 07.04.2015 21:00:00 - Listening: #R=27, T[°C]=23, VB[V]=10.36	Device is in record mode
SN2123 07.04.2015 22:00:00 - Listening: #R=32, T[°C]=22, VB[V]=10.34	Device status during record mode (listening for trigger event)
SN2123 07.04.2015 23:00:00 - Listening: #R=54, T[°C]=22, VB[V]=10.31	Number of recordings, actual temperature, battery voltage is logged
SN2123 08.04.2015 00:00:00 - Listening: #R=7, T[°C]=21, VB[V]=10.28	
SN2123 08.04.2015 01:00:00 - Listening: #R=10, T[°C]=21, VB[V]=10.27	
...	
SN2123 08.04.2015 08:17:09 - sleeping until 20:15 ...	End of time frame T1 is reached
SN2123 08.04.2015 11:57:08 - record mode stopped (wakeup by user)	Device is in sleep mode
SN2123 08.04.2015 11:57:13 - shutdown	Record mode was aborted by the user
	Device was shut-down

9.4 Parameter file "BATAPARS.xml"

The device settings are stored in the BATAPARS.xml file on the SD cards root directory. The parameter file is loaded upon device start-up. The file can be modified with any computer as it complies to the XML standard. Preferably it is edited with the BATPARS Editor Software, see chapter 3.3.

Settings, that are changed interactively on the device are also saved to the file.

When formatting an SD card, the parameter file will be preserved.

Without the "BATAPARS.xml" file on the SD card, the device starts with its internal "CMOS" parameters, which correspond to the values last set.

9.5 Google-Earth file "route.kml"

A new file is created if no "route.kml" file is available one a recording is stored for backwards compatibility reasons.

10 Troubleshooting

10.1 Checklist

<i>Problem</i>	<i>Cause</i>	<i>Remedy</i>
Device does not turn on.	Batteries are not installed properly.	Check batteries.
	Battery power is low.	Replace/recharge batteries.
A lot of noise is recorded.	Trigger settings not optimal.	Check and/or adapt trigger settings.
	Electromagnetic interferences.	Check installation and power supply. Connect microphone shield to ground.
	Noisy environment.	Change location and/or placement/orientation of microphone.
No recordings triggered.	Microphone is defective.	Check and/or replace microphone. See chapter 10.2.
	Trigger settings wrong.	Check and/or adapt trigger settings. See chapter 8.2.2.
“SD card error” is displayed.	SD card is full.	Delete files or format SD card.
	SD card is write protected.	Disable “Lock” switch on SD card.
	SD card is defective.	Check and/or replace SD card.
	SD card type is not supported.	Replace SD card with a valid type.
Device lost date/time information.	CR2032 battery is dead.	Replace CR2032 battery. Please contact a service centre near you.

10.2 Replace microphone

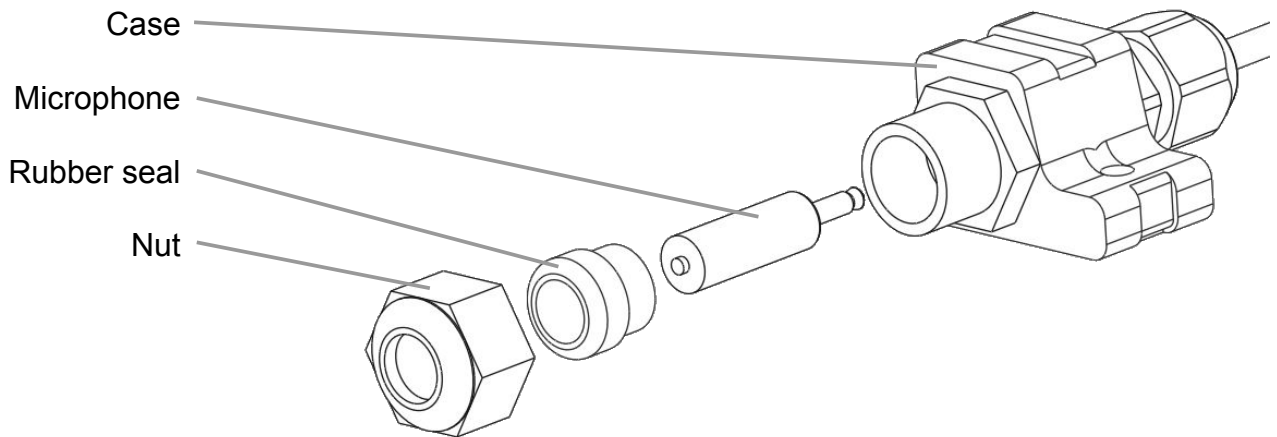

1. Remove the microphone case nut by unscrewing it counter-clockwise
2. Pull out the rubber seal
3. Pull out the microphone
4. Insert the new microphone carefully. Avoid touching the microphones top (capsule). Make sure it is fully inserted until you hear a “click”.
5. Insert the rubber seal
6. Mount the microphone case nut by screwing it clockwise by hand (max. torque 3 Nm)

10.3 Test microphone



Microphone testing: The ultrasonic microphone should be tested on a regular basis as it may become less sensitive over time, especially if it was exposed to moisture and weather. Keep it clean and dry to get best results.

10.3.1 Record silent spectrum

1. Place the white protective cover over the microphone in order to block any noise from reaching the microphone. Go in a silent environment.
2. Use the “manual test microphone” function (see chapter 8.2.3) or start a manual recording.
3. Compare the silent spectrum to the microphones specification.

10.3.2 Record a test tone

If you have access to an ultrasonic tone generator that produces reproducible output, you can record that tone and measure the frequency peak of the tone in the recording with appropriate audio software (e.g. Audacity).

10.4 Update device firmware



Power loss during update: If the device loses power during firmware update, it may get damaged and left unusable. Make sure that batteries are fully loaded before updating.

Download possible new firmware version from www.batlogger.com and copy it to the SD card.

Power up the device as in chapter 4.2.

```
New FWxxx.BA  
Flash Firmware >
```



Device starts up and detects new firmware file

Press  key to install the new firmware.

Press  key to skip firmware installation.

```
Programming  
xxxxxx Bytes...
```

The new firmware is flashed to the device. After flashing, the device needs to be restarted.

Press both keys  and  simultaneously to turn on the device again if it does not reboot by itself.

```
FW Verify Ok !  
Del. FW on SD? >
```

The installed firmware is then verified against the version stored on the SD card.

Press  key to delete the firmware file from the SD card.

Press  key to keep the firmware file e.g. to update another device.

Also see notes attached to the firmware file for further information.

11 Technical specifications

Case, dimensions	
Size (B x H x T)	113×81×72 mm (A), 113×101×81 mm (A+),
Weight	576 g (A), 695 g (A+) (with batteries and microphone)
Weather protection	IP67 (except microphone)
Operating conditions	-10..+50°C, 10..90%RH (non condensing) Charger (A+): 0..+40°C
Storage conditions	-20..+60°C, 5..95%RH (non condensing)
Power	
Batteries (A)	8× 1.5V AA (HR6) Mignon batteries or 1.2V AA rechargeable batteries, Operating time approx. 3 nights a 9h
Battery (A+)	7.2V 6900 mAh Li-Ion rechargeable battery BP-945 Operating time approx. 5 nights a 10h
Audio	
Sampling	312.5 kHz, 16 bits
Microphone	Ultrasonic microphone FG black, Waterproof cable 2m
Sensitivity range	10 – 150 kHz
Recording duration	0 – 53.5 sec per file, pre- and post-trigger configurable
Trigger modes	Manual, Continuous, Crest Adv, Crest, Period
Scheduled recording	Two time frames programmable per day for recordings (time of the day)
Interval recording	Recording in intervals with preset pause times (number of minutes)
Data storage	
File formats	*.wav, *.xml, *.kml, *.gpx, *.log
Storage media	Micro SD/SDHC/SDXC card (SD 2.0), max. 128GB, FAT32 formatted
Software	
Settings and configuration	BATPARS Editor (WIN, MAC)
Analysis and species identification	BatExplorer (WIN) BatScope (MAC)
Various	
Location	A manual recording location can be set.

12 Exclusion of Warranty

Elekon AG assumes no liability and provides no warranty for damage resulting from improper installation, mounting and improper use of the product or from failure to observe the operating instructions and/or safety notes.

13 Service and Support

Please contact Elekon AG if you have any questions about this product:

+41 41 2504040 or mail@elekon.ch

Further support information can be found on: www.batlogger.com



Made in Switzerland
February 2016

© 2016 Elekon AG, All rights reserved. Elekon, the Elekon logo and BATLOGGER are trademarks and / or registered trademarks of Elekon AG. Other brand and product names are trademarks or registered trademarks of their respective owners. Information may be changed without prior notice.

elekon
●●●

Elekon AG
Cheerstrasse 16
CH-6014 Luzern

www.batlogger.com